

1W HI-POWER LED SPECIFICATION

HPR8C-49KxWx

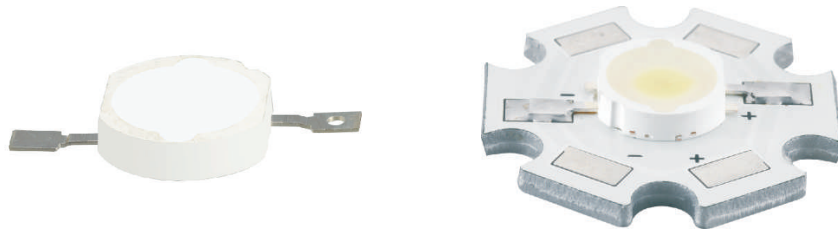

| Drawn by | Checked by | Approved by |
|----------|------------|-------------|
| | | |
| | | |



DATE:2010/4/29

REV:E

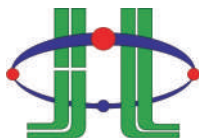

HUEY JANN ELECTRONICS INDUSTRY CO., LTD.

No.27 Line 466 Sec.2,Cannng-nan Rd. Wu-chi Town Taichung Shien, Taiwan, R.O.C.

TEL:+886-4-26393976 FAX:+886-4-26393125

HUEY JANN High Power 1W LED is made of GaInN chips with precise package technique which makes excellent heat dissipation to reach the advantages of high luminous efficiency, low decay, and long endurance. Now we have these colors available: red, green, blue, white, yellow and infrared.

☰ **FEATERUS**

- Instant light
- Long operating life
- Superior ESD defense
- Low voltage DC operated
- More energy efficient than incandescent and most halogen lamps

☰ **TYPICAL APPLICATIONS**

- Architectural detail lighting
- Portable flashlight
- Medical applications
- Beacon lights
- Decoration lights
- Spotlight

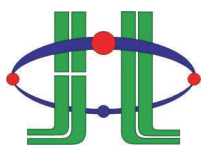

HUEY JANN ELECTRONICS INDUSTRY CO., LTD.

No.27 Line 466 Sec.2,Cannng-nan Rd. Wu-chi Town Taichung Shien, Taiwan, R.O.C.

TEL:+886-4-26393976 FAX:+886-4-26393125

Explanation of Part Number:

H P R 8 C - 4 9K x xWx / WPCB
① ② ③ ④ ⑤ ⑥ ⑦ ⑧ ⑨ ⑩

1.H: Huey Jann

2.P: High power LED Type

3.Shape distinguish:

B: Lambertian type S: Side emitting type
D: Focusing type E: Focusing type
R: Reflector type

4.Identification no:

5.Lead frame type

6.Appearance:

1:White Diffusion
4:Water Clear

7.Color number:

3K: Green 4K: Yellow
5K: Red 8K: Blue
9K: White

8.Power type:

Non: 1W 05: 0.5W
3: 3W 5: 5W

9.Color kind:

W: Pure White YW: Warm White
WD: Pure White YWD: Warm White
WG: Pure White YWG: Warm White
WGA: Pure White YWGA: Warm White
YW(4000°K): Nature White
YWD(4000°K): Nature White
YWG(4000°K): Nature White
YWGA(4000°K): Nature White

10.Heat conduction type:

Non: emitter type
/WPCB: with white star type heat sink

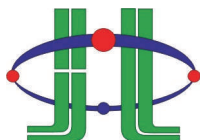

HUEY JANN ELECTRONICS INDUSTRY CO., LTD.

No.27 Line 466 Sec.2,Cannng-nan Rd. Wu-chi Town Taichung Shien, Taiwan, R.O.C.

TEL:+886-4-26393976 FAX:+886-4-26393125

☰ **DEVICES**

Emitter Type

IF=350mA TA=25°C

| Item | Lens Color | Dice Source | Color Temperature Typ (°K) | Luminous Intensity Typ (lm) |
|-----------------------|-------------|-------------|----------------------------|-----------------------------|
| HPR8C-49KW | Water Clear | GaInN/GaN | 6000 | 60 |
| HPR8C-49KWD | | | | 90 |
| HPR8C-49KWG | | | | 105 |
| HPR8C-49KWGA | | | | 125 |
| HPR8C-49KYW(4000°K) | | | 4000 | 58 |
| HPR8C-49KYWD(4000°K) | | | | 86 |
| HPR8C-49KYWG(4000°K) | | | | 100 |
| HPR8C-49KYWGA(4000°K) | | | | 119 |
| HPR8C-49KYW | | | 3300 | 55 |
| HPR8C-49KYWD | | | | 81 |
| HPR8C-49KYWG | | | | 95 |
| HPR8C-49KYWGA | | | | 110 |

*Tolerance: 15% HUEY-JANN measuring equipment : EXELTRON 2001. 2.S370 made by U.D.T.

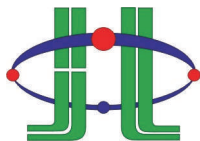

HUEY JANN ELECTRONICS INDUSTRY CO., LTD.

No.27 Line 466 Sec.2,Cannng-nan Rd. Wu-chi Town Taichung Shien, Taiwan, R.O.C.

TEL:+886-4-26393976 FAX:+886-4-26393125

☰ **DEVICES**

With White Star MCPCB Type

IF=350mA TA=25°C

| Item | Lens Color | Dice Source | Color Temperature Typ (°K) | Luminous Intensity Typ (lm) |
|----------------------------|-------------|-------------|----------------------------|-----------------------------|
| HPR8C-49KW/WPCB | Water Clear | GaInN/GaN | 6000 | 60 |
| HPR8C-49KWD/WPCB | | | | 90 |
| HPR8C-49KWG/WPCB | | | | 105 |
| HPR8C-49KWGA/WPCB | | | | 125 |
| HPR8C-49KYW/WPCB(4000°K) | | | 4000 | 58 |
| HPR8C-49KYWD/WPCB(4000°K) | | | | 86 |
| HPR8C-49KYWG/WPCB(4000°K) | | | | 100 |
| HPR8C-49KYWGA/WPCB(4000°K) | | | | 119 |
| HPR8C-49KYW/WPCB | | | 3300 | 55 |
| HPR8C-49KYWD/WPCB | | | | 81 |
| HPR8C-49KYWG/WPCB | | | | 95 |
| HPR8C-49KYWGA/WPCB | | | | 110 |

*Tolerance: 15% HUEY-JANN measuring equipment : EXELTRON 2001. 2.S370 made by U.D.T.

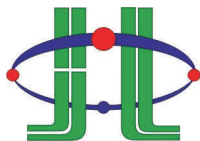

HUEY JANN ELECTRONICS INDUSTRY CO., LTD.

No.27 Line 466 Sec.2,Cannng-nan Rd. Wu-chi Town Taichung Shien, Taiwan, R.O.C.

TEL:+886-4-26393976 FAX:+886-4-26393125

PACKAGE DIMENSIONS:

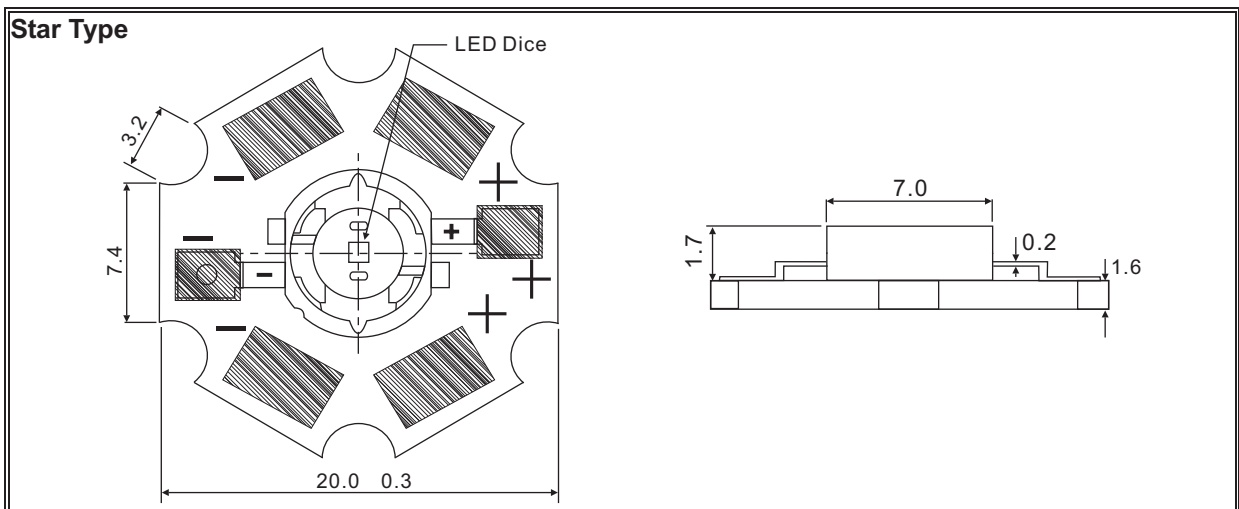
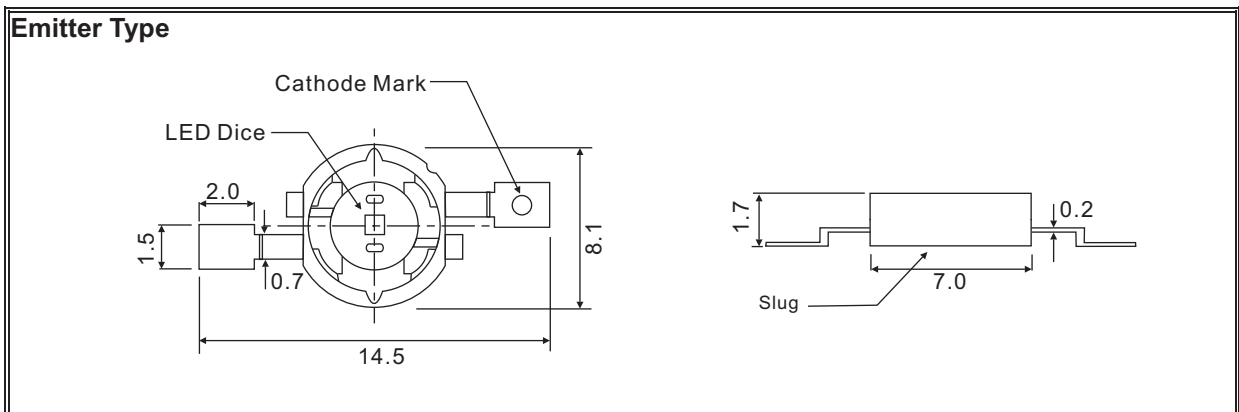

NOTE:

- 1.All dimensions are in millimeter.
- 2.Lead spacing in measured where the lead emerge from the package.
- 3.prodruded resin under flange is 1.5mm max.
- 4.specifications are subject to change without notice.
- 5.Tolerance is 0.3mm unless otherwise noted.
- 6.Driving LED without heat sinking device is forbidden.
- 7.It is strongly recommended that the temperature of lead be not higher than 55°C.
- 8.Proper current derating must be observed to maintain junction temperature below the maximum.
- 9.LEDs are not designed to be driven in reserve bias.

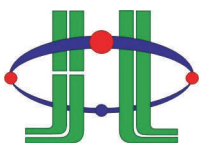

HUEY JANN ELECTRONICS INDUSTRY CO., LTD.

No.27 Line 466 Sec.2,Cannng-nan Rd. Wu-chi Town Taichung Shien, Taiwan, R.O.C.

TEL:+886-4-26393976 FAX:+886-4-26393125

ABSOLUTE MAXIMUM RATINGS

TA=25°C

| PARAMETER | SYMBOL | MAX. RATING | UNIT |
|--|--------|-------------|------|
| Continuous Forward Current | IF | 350 | mA |
| Peak Forward Current *1 | IFM | 500 | mA |
| Electrostatic Discharge(HBM) | ESD | 4000 | V |
| LED Junction Temperature | Tj | 135 | °C |
| Operating Temperature | Topr | -40 ~ +110 | °C |
| Storage Temperature | Tstg | -40 ~ +120 | °C |
| Manual Soldering Temperature 260 °C for 5 seconds max. *2 *3 | | | |

*1.Duty Ratio=0.1%,Pulse Width=10us.

*2.Iron soldering high temperature will not cause damage to the dice. But be aware of the high temperature will not only make the epoxy soften but also cause the lead moving and the gold wire broken and even open. So before returning to the normal temperatures PLEASE AVOID any serious pressure on the top of epoxy and lead.

*3.Measured at leads, lens temperature must not exceed 120°C during lead soldering and slug attach. Soldering by general IR reflow, Vapor phase reflow and wave soldering on this system product is unsuitable. Selective heating of the leads limit lead soldering, such as by hot bar reflow, fiber focussed IR, or hand soldering. The package back plane (slug) may not be attached by soldering, but rather with a thermally conductive adhesive. Electrical insulation between the slug and the board is necessary. Please consult welding matters needing attention.

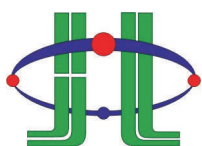

HUEY JANN ELECTRONICS INDUSTRY CO., LTD.

No.27 Line 466 Sec.2,Canng-nan Rd. Wu-chi Town Taichung Shien, Taiwan, R.O.C.

TEL:+886-4-26393976 FAX:+886-4-26393125

ELECTRIC-OPTICAL CHARACTERISTICS

TA=25°C

| PARAMETER | SYMBOL | TEST CONDITION | TYP | MAX | UNIT |
|--|---------------------|----------------|-----|-----|-------|
| View Angle of Half Power | 2θ _{1/2} | IF=350mA | 110 | | deg |
| Forward Voltage For HPR8C-49KxWx | VF | | 3.6 | 4.2 | V |
| Forward Voltage For HPR8C-49KxWDx | VF | | 3.5 | 4.0 | V |
| Forward Voltage For HPR8C-49KxWGx | VF | | 3.5 | 4.0 | V |
| Forward Voltage For HPR8C-49KxWGAx | VF | | 3.6 | 4.2 | V |
| Color Rendering Index For 4000°K | CRI | | | 75 | |
| Color Rendering Index For 3300°K | CRI | | | 70 | |
| Thermal Resistance Junction To Case | Rθ _{J-C} | | 15 | | °C/W |
| Thermal Resistance Junction To Case With Star Type Heat Sink | Rθ _{J-C} | | 20 | | °C/W |
| Temperature Coefficient Of Forward Voltage | ΔV _F /ΔT | | -2 | | mV/°C |

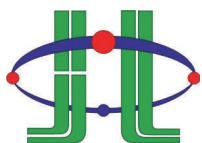

HUEY JANN ELECTRONICS INDUSTRY CO., LTD.

No.27 Line 466 Sec.2,Cannng-nan Rd. Wu-chi Town Taichung Shien, Taiwan, R.O.C.

TEL:+886-4-26393976 FAX:+886-4-26393125

RELIABILITY TEST

Endurance Test

| Test Item | Reference Standard | Test Conditions | Result |
|--|---|--|--------|
| Operation Life | MIL-STD-750:1026 MIL-STD-883:1005 JIS-C-7021 :B-1 | Connect with a power if=350mA Ta=Under room temperature Test Time=1,000hrs | 0/22 |
| High Temperature High Humidity Storage | MIL-STD-202:103B JIS-C-7021 :B-11 | Ta=+85°C 5°C RH=80% ~ 85% Test Time=1,000hrs | 0/22 |
| High Temperature Storage | MIL-STD-883:1008 JIS-C-7021 :B-10 | High Ta=+120°C 5°C Test Time=1,000hrs | 0/22 |
| Low Temperature Storage | JIS-C-7021 :B-12 | Low Ta=-40°C 5°C Test Time=1,000hrs | 0/22 |

*Failure Criteria:

1. VF arise \geq 10%
2. IV decline \geq 30%
3. A failure is an LED that is open or shorted

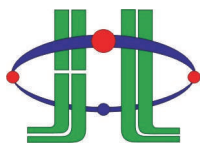

HUEY JANN ELECTRONICS INDUSTRY CO., LTD.

No.27 Line 466 Sec.2,Cannng-nan Rd. Wu-chi Town Taichung Shien, Taiwan, R.O.C.

TEL:+886-4-26393976 FAX:+886-4-26393125

RELIABILITY TEST

➤ Environmental Test

| Test Item | Reference Standard | Test Conditions | Result |
|---------------------|---|--|--------|
| Temperature Cycling | MIL-STD-202:107D MIL-STD-750:1051 MIL-STD-883:1010 JIS-C-7021 :A-4 | -40°C ~ +25°C ~ +85°C ~ +25°C 60min 20min 60min 20min Test Time=200cycle | 0/22 |
| Thermal Shock | MIL-STD-202:107D MIL-STD-750:1051 MIL-STD-883:1010 | -40°C 5°C ~ +110°C 5°C 20min 20min Test Time=200cycle | 0/22 |

*Failure Criteria:

1. VF arise \geq 10%
2. IV decline \geq 30%
3. A failure is an LED that is open or shorted

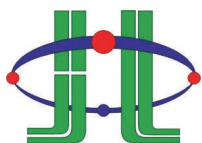

HUEY JANN ELECTRONICS INDUSTRY CO., LTD.

No.27 Line 466 Sec.2,Cannng-nan Rd. Wu-chi Town Taichung Shien, Taiwan, R.O.C.

TEL:+886-4-26393976 FAX:+886-4-26393125

TYPICAL ELECTRICAL OPTICAL CHARACTERISTICS CURVES

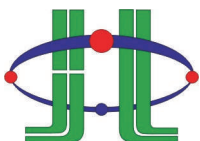
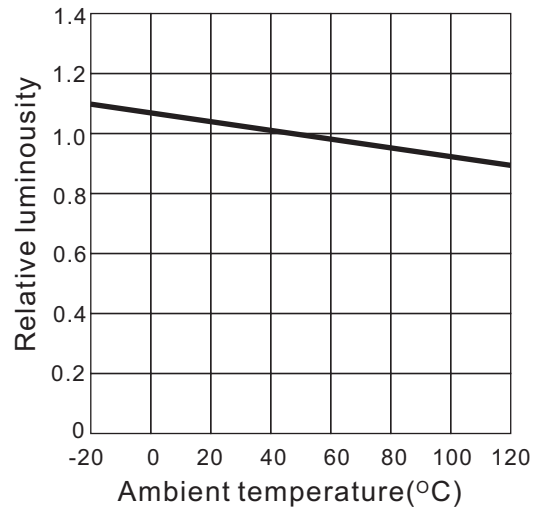
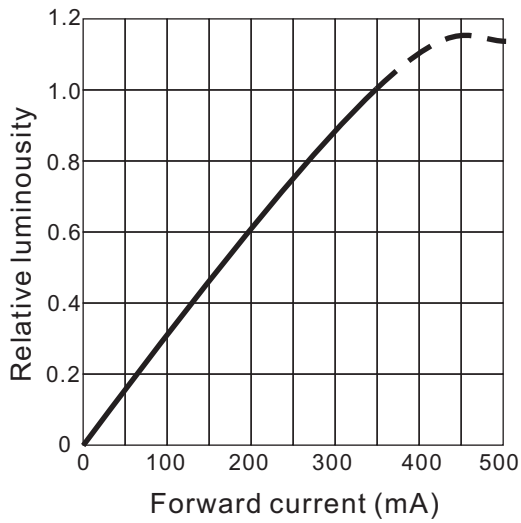
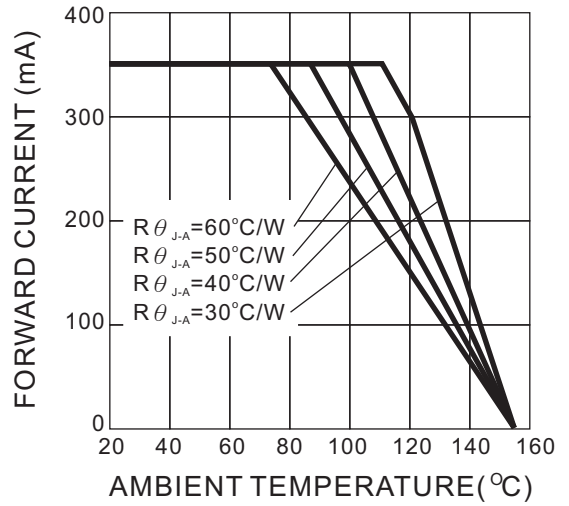
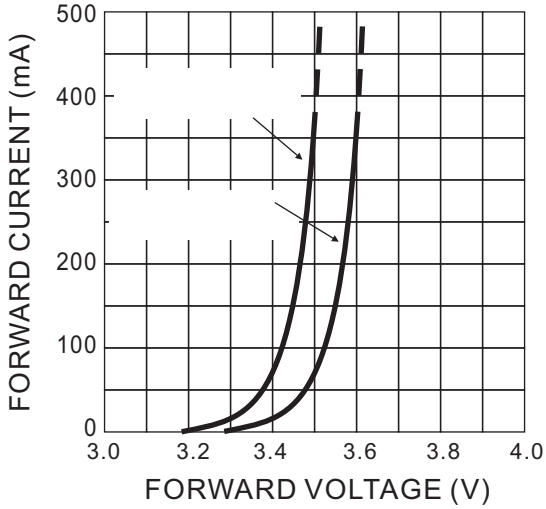

HUEY JANN ELECTRONICS INDUSTRY CO., LTD.

No.27 Line 466 Sec.2,Cannng-nan Rd. Wu-chi Town Taichung Shien, Taiwan, R.O.C.

TEL:+886-4-26393976 FAX:+886-4-26393125

TYPICAL ELECTRICAL OPTICAL CHARACTERISTICS CURVES

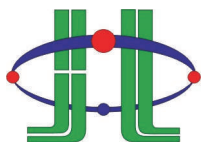
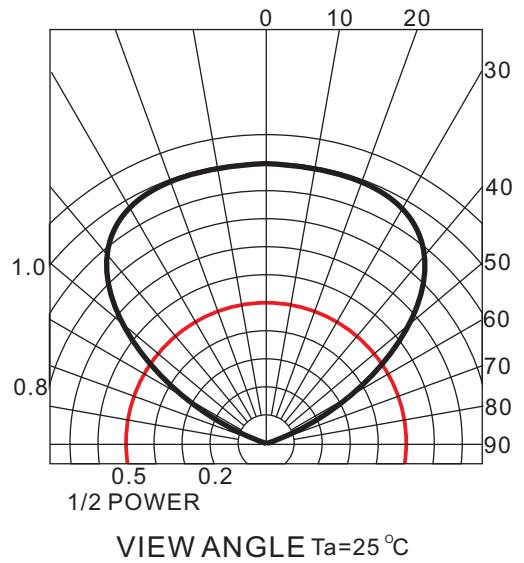
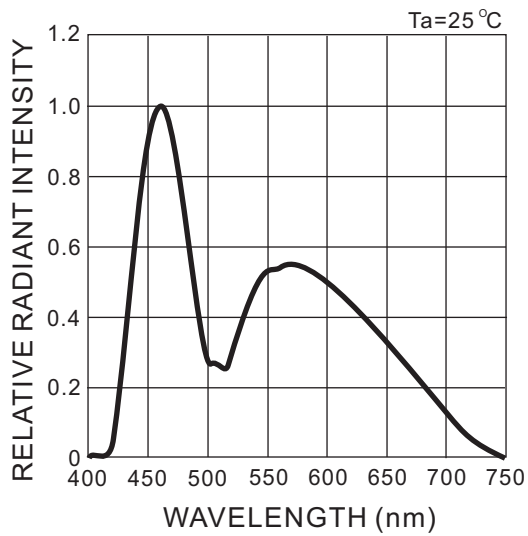
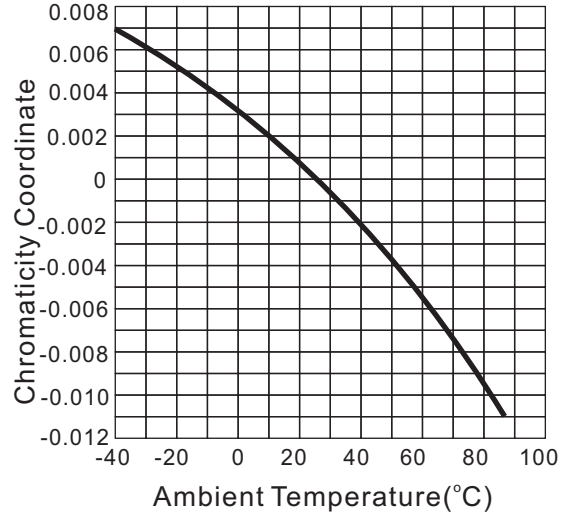
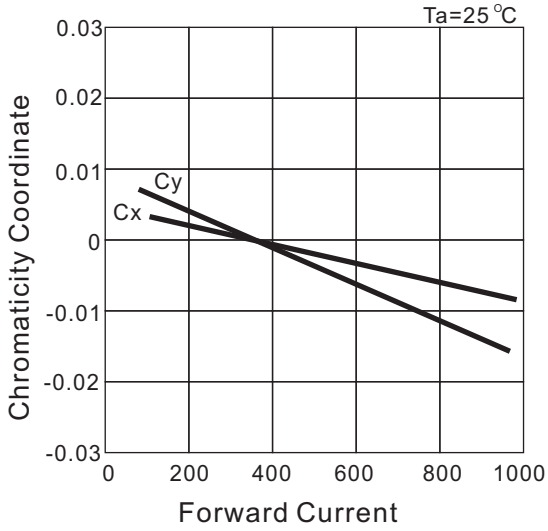

HUEY JANN ELECTRONICS INDUSTRY CO., LTD.

No.27 Line 466 Sec.2, Canng-nan Rd. Wu-chi Town Taichung Shien, Taiwan, R.O.C.

TEL:+886-4-26393976 FAX:+886-4-26393125

Brightness Bin Selection

For HPR8C-49KxWx

| Item | Emitter Color | BIN CODE | Brightness in lm | |
|----------------------|---------------|----------|------------------|---------|
| | | | Minimum | Maximum |
| HPR8C-49KWx | Pure White | J | 50 | 65 |
| HPR8C-49KYWx(4000°K) | Nature White | J | 50 | 65 |
| HPR8C-49KYWx | Warm White | J | 50 | 65 |

For HPR8C-49KxWDx

| Item | Emitter Color | BIN CODE | Brightness in lm | |
|-----------------------|---------------|----------|------------------|---------|
| | | | Minimum | Maximum |
| HPR8C-49KWDx | Pure White | K | 65 | 85 |
| | | L | 85 | 110 |
| HPR8C-49KYWDx(4000°K) | Nature White | K | 65 | 85 |
| | | L | 85 | 110 |
| HPR8C-49KYWDx | Warm White | K | 65 | 85 |

NOTE:

1. Test Condition at IF=350mA.
2. Brightness tolerance for each bin limit is $\pm 15\%$

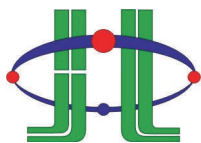

HUEY JANN ELECTRONICS INDUSTRY CO., LTD.

No.27 Line 466 Sec.2,Canng-nan Rd. Wu-chi Town Taichung Shien, Taiwan, R.O.C.

TEL:+886-4-26393976 FAX:+886-4-26393125

Brightness Bin Selection

For HPR8C-49KxWGx

| Item | Emitter Color | BIN CODE | Brightness in lm | |
|-----------------------|---------------|----------|------------------|---------|
| | | | Minimum | Maximum |
| HPR8C-49KWGx | Pure White | L | 85 | 110 |
| | | M | 110 | 143 |
| HPR8C-49KYWGx(4000°K) | Nature White | L | 85 | 110 |
| HPR8C-49KYWGx | Warm White | L | 85 | 110 |

For HPR8C-49KxWGx

| Item | Emitter Color | BIN CODE | Brightness in lm | |
|------------------------|---------------|----------|------------------|---------|
| | | | Minimum | Maximum |
| HPR8C-49KWGAx | Pure White | M | 110 | 143 |
| HPR8C-49KYWGAx(4000°K) | Nature White | M | 110 | 143 |
| HPR8C-49KYWGAx | Warm White | L | 85 | 110 |
| | | M | 110 | 143 |

NOTE:

1. Test Condition at IF=350mA.
2. Brightness tolerance for each bin limit is ±15%

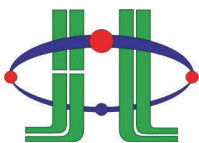

HUEY JANN ELECTRONICS INDUSTRY CO., LTD.

No.27 Line 466 Sec.2,Cannng-nan Rd. Wu-chi Town Taichung Shien, Taiwan, R.O.C.

TEL:+886-4-26393976 FAX:+886-4-26393125

Pure White Color Bin Selection

| Bin | CCT(°K) | Chromaticity Coordinates | | | | |
|------------------|---------|--------------------------|----------|-------|----------|-------|
| | TYP | | | | | |
| T1 | 9000 | x | 0.274 | 0.292 | 0.299 | 0.283 |
| | | y | 0.301 | 0.322 | 0.300 | 0.284 |
| T2 | 9000 | x | 0.283 | 0.299 | 0.303 | 0.290 |
| | | y | 0.284 | 0.300 | 0.283 | 0.270 |
| T3 | 8000 | x | 0.292 | 0.303 | 0.308 | 0.299 |
| | | y | 0.322 | 0.333 | 0.311 | 0.300 |
| T4 | 8000 | x | 0.299 | 0.308 | 0.311 | 0.303 |
| | | y | 0.300 | 0.311 | 0.293 | 0.283 |
| T5 | 6700 | x | 0.301 | 0.314 | 0.316 | 0.305 |
| | | y | 0.342 | 0.355 | 0.333 | 0.322 |
| T6 | 6700 | x | 0.305 | 0.316 | 0.317 | 0.308 |
| | | y | 0.322 | 0.333 | 0.320 | 0.311 |
| T7 | 6700 | x | 0.308 | 0.317 | 0.319 | 0.311 |
| | | y | 0.311 | 0.320 | 0.300 | 0.293 |
| T8 | 6000 | x | 0.314 | 0.329 | 0.329 | 0.316 |
| | | y | 0.355 | 0.369 | 0.345 | 0.333 |
| T9 | 6000 | x | 0.316 | 0.329 | 0.329 | 0.317 |
| | | y | 0.333 | 0.345 | 0.331 | 0.320 |
| T10 | 6000 | x | 0.317 | 0.329 | 0.329 | 0.319 |
| | | y | 0.320 | 0.331 | 0.310 | 0.300 |
| T11 | 5300 | x | 0.329 | 0.348 | 0.346 | 0.329 |
| | | y | 0.369 | 0.385 | 0.359 | 0.345 |
| T12 | 5300 | x | 0.329 | 0.346 | 0.329 | 0.344 |
| | | y | 0.345 | 0.359 | 0.331 | 0.344 |
| T13 | 5300 | x | 0.344 | 0.329 | 0.343 | 0.329 |
| | | y | 0.344 | 0.331 | 0.331 | 0.320 |
| T14 | 4750 | x | 0.348 | 0.367 | 0.362 | 0.346 |
| | | y | 0.385 | 0.400 | 0.372 | 0.359 |
| T15 | 4750 | x | 0.346 | 0.362 | 0.360 | 0.344 |
| | | y | 0.359 | 0.372 | 0.357 | 0.344 |
| Tolerance | | | x ± 0.02 | | y ± 0.02 | |

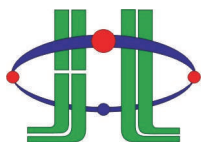

HUEY JANN ELECTRONICS INDUSTRY CO., LTD.

No.27 Line 466 Sec.2,Canng-nan Rd. Wu-chi Town Taichung Shien, Taiwan, R.O.C.

TEL:+886-4-26393976 FAX:+886-4-26393125

Pure White Color Bin Selection

CIE Light Color Chart

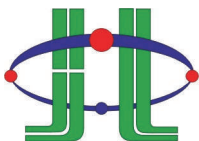
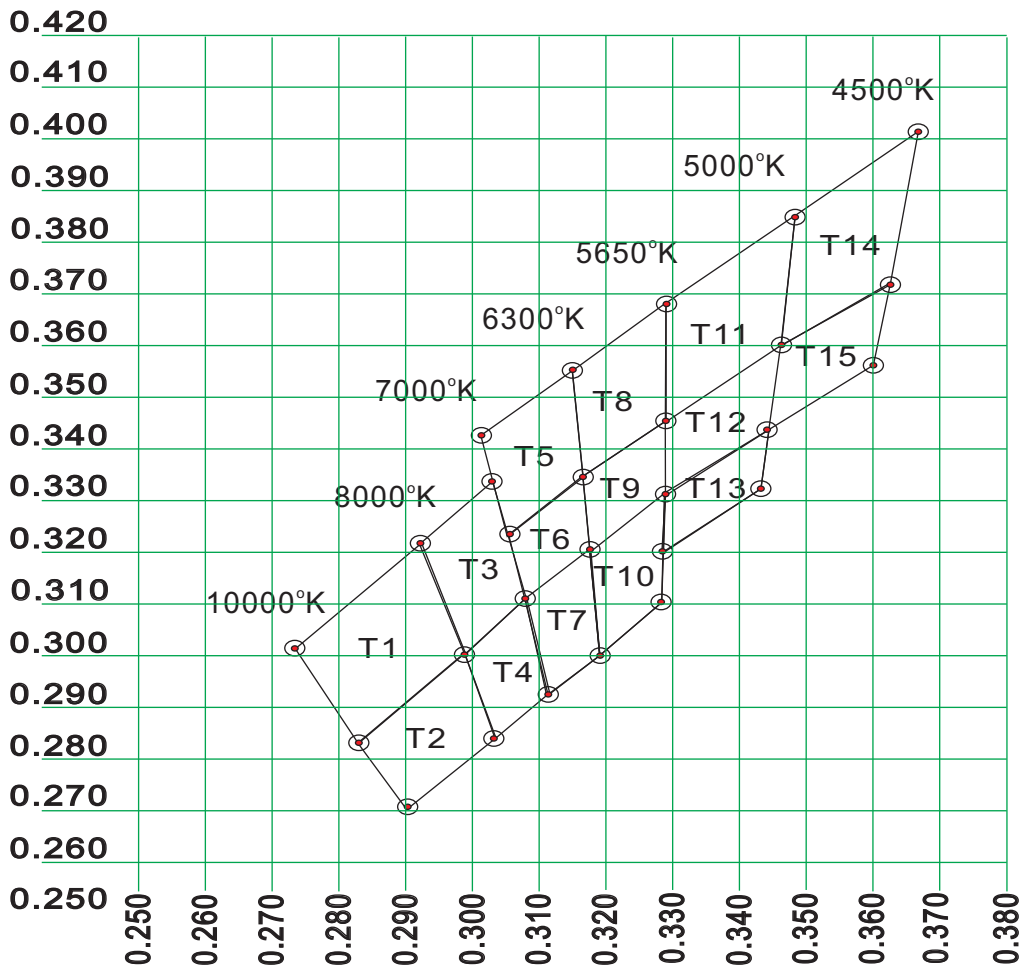

HUEY JANN ELECTRONICS INDUSTRY CO., LTD.

No.27 Line 466 Sec.2, Canning-nan Rd. Wu-chi Town Taichung Shien, Taiwan, R.O.C.

TEL:+886-4-26393976 FAX:+886-4-26393125

Nature White Color Bin Selection

| Bin | CCT(°K) | Chromaticity Coordinates | | | | |
|------------------|---------|--------------------------|-------|-------|----------|-------|
| | TYP | | | | | |
| N1 | 4300 | x | 0.367 | 0.385 | 0.381 | 0.364 |
| | | y | 0.400 | 0.412 | 0.393 | 0.382 |
| N2 | 4300 | x | 0.364 | 0.381 | 0.378 | 0.362 |
| | | y | 0.382 | 0.393 | 0.382 | 0.371 |
| N3 | 4300 | x | 0.362 | 0.378 | 0.374 | 0.359 |
| | | y | 0.371 | 0.382 | 0.365 | 0.355 |
| N4 | 4300 | x | 0.359 | 0.374 | 0.370 | 0.357 |
| | | y | 0.355 | 0.365 | 0.351 | 0.342 |
| N5 | 3950 | x | 0.385 | 0.402 | 0.396 | 0.381 |
| | | y | 0.412 | 0.422 | 0.403 | 0.393 |
| N6 | 3950 | x | 0.381 | 0.396 | 0.392 | 0.378 |
| | | y | 0.393 | 0.403 | 0.390 | 0.382 |
| N7 | 3950 | x | 0.378 | 0.392 | 0.387 | 0.374 |
| | | y | 0.382 | 0.390 | 0.373 | 0.365 |
| N8 | 3950 | x | 0.370 | 0.387 | 0.382 | 0.357 |
| | | y | 0.351 | 0.373 | 0.359 | 0.342 |
| N9 | 3650 | x | 0.402 | 0.420 | 0.414 | 0.396 |
| | | y | 0.422 | 0.432 | 0.416 | 0.403 |
| N10 | 3650 | x | 0.396 | 0.414 | 0.408 | 0.392 |
| | | y | 0.403 | 0.416 | 0.399 | 0.390 |
| N11 | 3650 | x | 0.392 | 0.408 | 0.402 | 0.387 |
| | | y | 0.390 | 0.399 | 0.382 | 0.373 |
| N12 | 3650 | x | 0.387 | 0.402 | 0.396 | 0.382 |
| | | y | 0.373 | 0.382 | 0.367 | 0.359 |
| Tolerance | | x ± 0.02 | | | y ± 0.02 | |

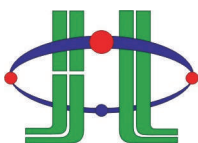

HUEY JANN ELECTRONICS INDUSTRY CO., LTD.

No.27 Line 466 Sec.2,Cannng-nan Rd. Wu-chi Town Taichung Shien, Taiwan, R.O.C.

TEL:+886-4-26393976 FAX:+886-4-26393125

Nature White Color Bin Selection

CIE Light Color Chart

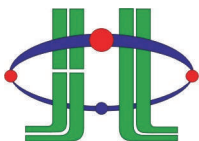
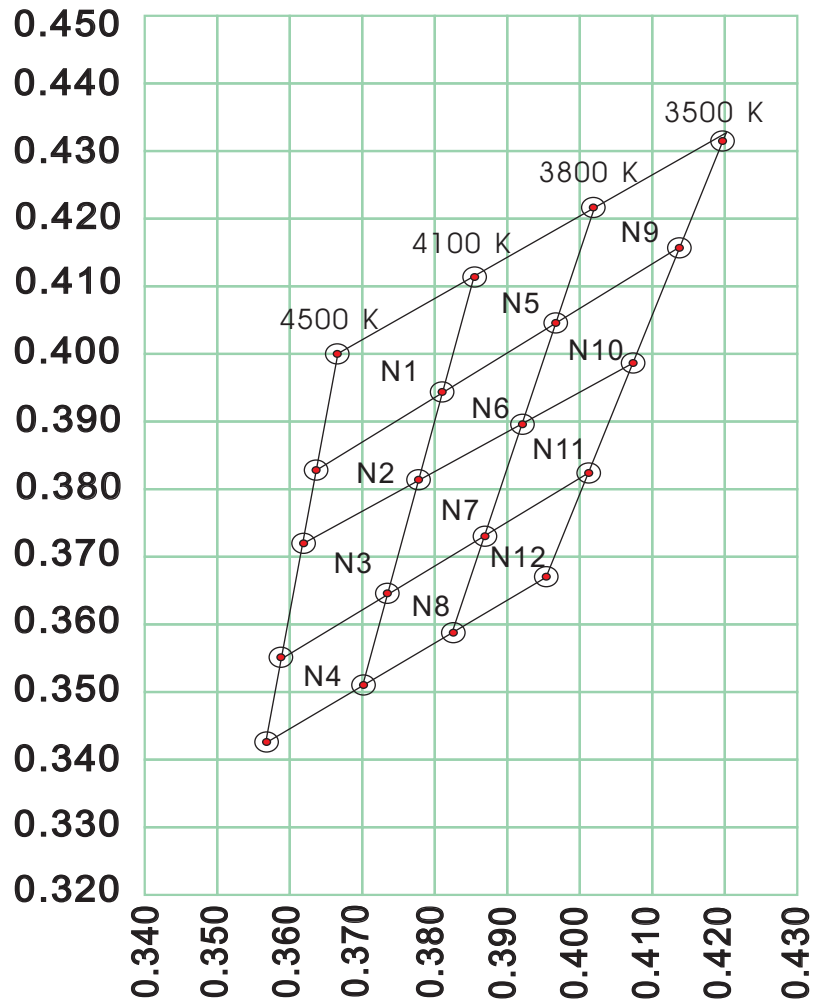

HUEY JANN ELECTRONICS INDUSTRY CO., LTD.

No.27 Line 466 Sec.2,Canng-nan Rd. Wu-chi Town Taichung Shien, Taiwan, R.O.C.

TEL:+886-4-26393976 FAX:+886-4-26393125

Warm White Color Bin Selection

| Bin | CCT(°K) | Chromaticity Coordinates | | | | |
|------------------|---------|--------------------------|----------|-------|----------|-------|
| | TYP | | | | | |
| C10 | 3640 | x | 0.402 | 0.417 | 0.409 | 0.392 |
| | | y | 0.423 | 0.431 | 0.400 | 0.391 |
| C11 | 3500 | x | 0.402 | 0.438 | 0.424 | 0.392 |
| | | y | 0.423 | 0.440 | 0.406 | 0.391 |
| C12 | 3640 | x | 0.392 | 0.409 | 0.402 | 0.387 |
| | | y | 0.391 | 0.400 | 0.382 | 0.374 |
| C13 | 3370 | x | 0.409 | 0.424 | 0.416 | 0.402 |
| | | y | 0.400 | 0.406 | 0.389 | 0.382 |
| C14 | 3500 | x | 0.387 | 0.416 | 0.410 | 0.383 |
| | | y | 0.374 | 0.389 | 0.374 | 0.360 |
| C15 | 3150 | x | 0.438 | 0.454 | 0.438 | 0.424 |
| | | y | 0.440 | 0.446 | 0.412 | 0.406 |
| C16 | 3150 | x | 0.424 | 0.438 | 0.429 | 0.416 |
| | | y | 0.406 | 0.412 | 0.394 | 0.389 |
| C17 | 2950 | x | 0.454 | 0.471 | 0.453 | 0.438 |
| | | y | 0.446 | 0.451 | 0.416 | 0.412 |
| C18 | 2950 | x | 0.438 | 0.453 | 0.444 | 0.429 |
| | | y | 0.412 | 0.416 | 0.399 | 0.394 |
| Tolerance | | | x ± 0.02 | | y ± 0.02 | |

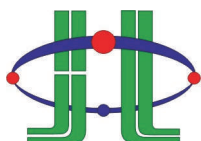

HUEY JANN ELECTRONICS INDUSTRY CO., LTD.

No.27 Line 466 Sec.2,Canng-nan Rd. Wu-chi Town Taichung Shien, Taiwan, R.O.C.

TEL:+886-4-26393976 FAX:+886-4-26393125

Warm White Color Bin Selection

CIE Light Color Chart

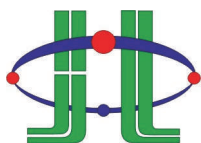
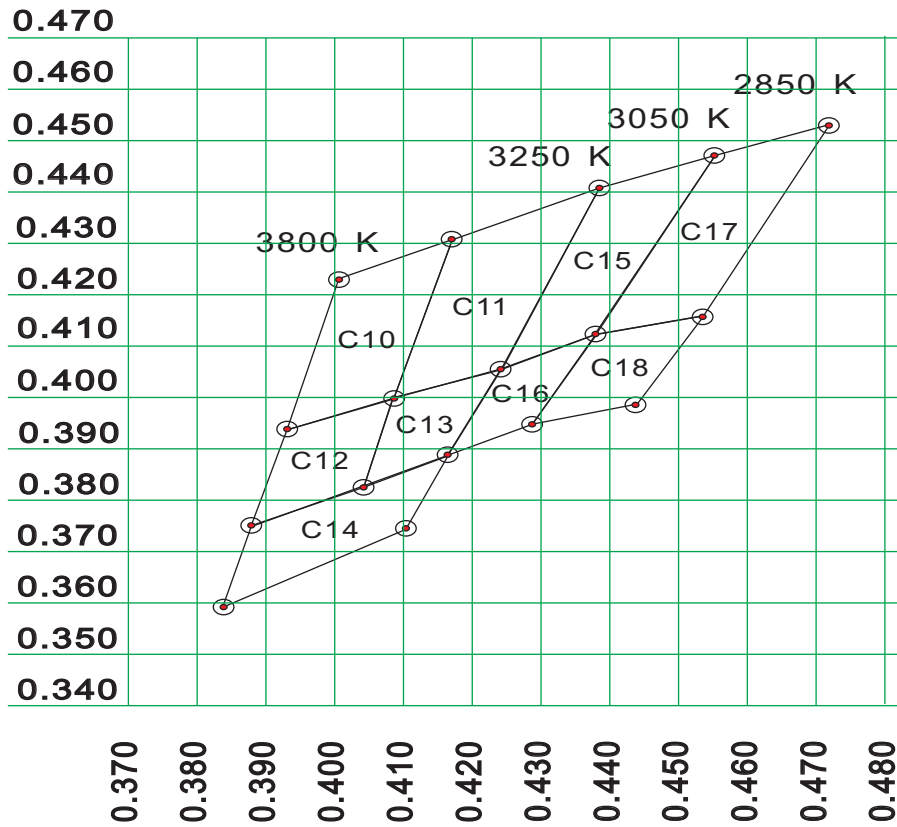

HUEY JANN ELECTRONICS INDUSTRY CO., LTD.

No.27 Line 466 Sec.2,Canng-nan Rd. Wu-chi Town Taichung Shien, Taiwan, R.O.C.

TEL:+886-4-26393976 FAX:+886-4-26393125

Package Dimension For Emitter Type

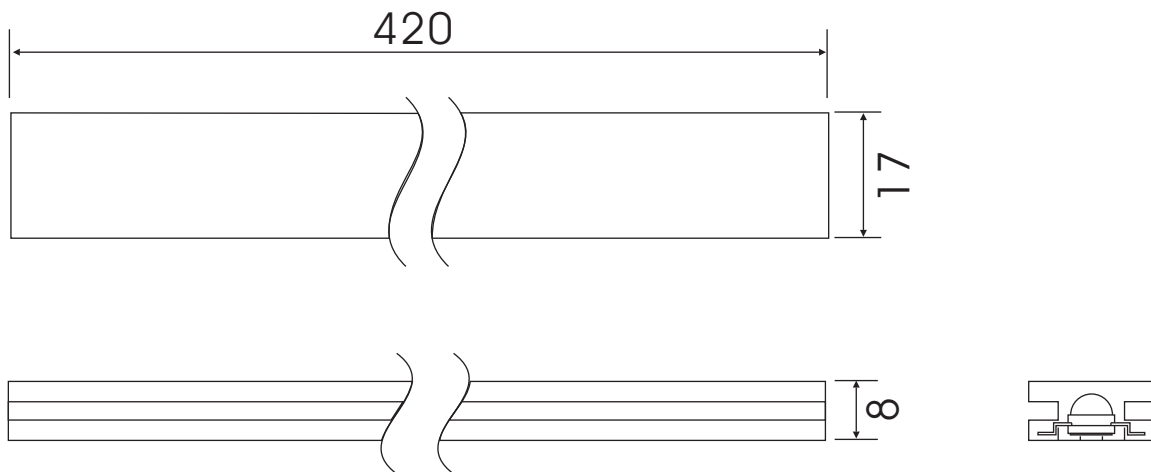

NOTE:

1. Dimensions are specified as follows: mm.
2. Tolerance is 0.3mm unless otherwise noted.
3. 50 pcs emitters per tube.
4. 80 tubes per inside box.
5. 4 inside box per outside box.

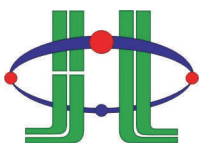

HUEY JANN ELECTRONICS INDUSTRY CO., LTD.

No.27 Line 466 Sec.2,Canng-nan Rd. Wu-chi Town Taichung Shien, Taiwan, R.O.C.

TEL:+886-4-26393976 FAX:+886-4-26393125

Package Dimension For Star Type

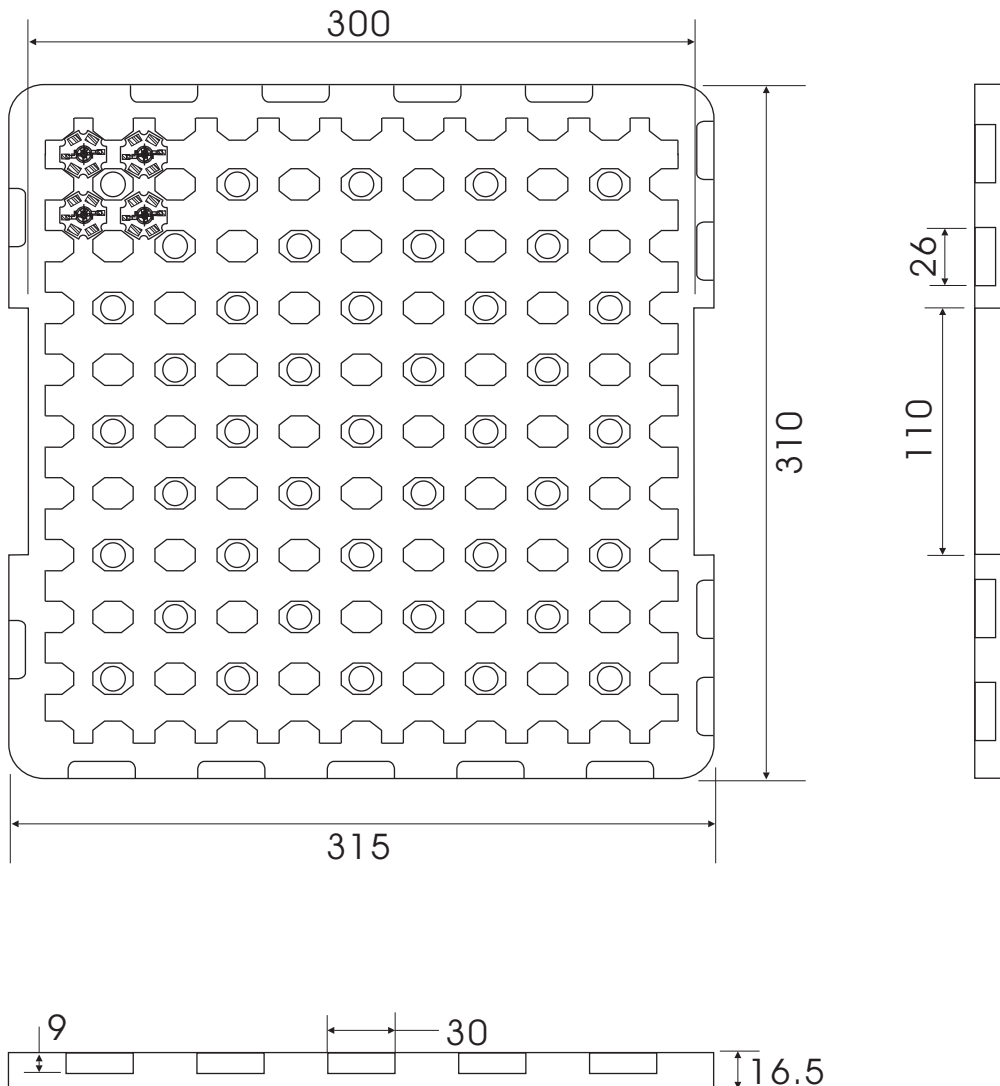

NOTE:

1. Dimensions are specified as follows: mm.
2. Tolerance is 0.3mm unless otherwise noted.
3. 100pcs star per tray.
4. 10 trays per box.

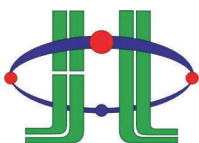

HUEY JANN ELECTRONICS INDUSTRY CO., LTD.

No.27 Line 466 Sec.2,Canng-nan Rd. Wu-chi Town Taichung Shien, Taiwan, R.O.C.

TEL:+886-4-26393976 FAX:+886-4-26393125

Requirements to user For Emitter Type

The LED products by HUEY-JANN is designed, manufactured, and sold aiming at high standard quality and reliability, however, reliability of electronic apparatus is seen as a product of reliability superior to HUEY-JANN and using status at users. From this point, HUEY-JANN requests user's for following things.

Please do not extrude the colloid

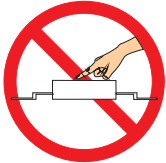

Recommended Solder Pad Design For Emitter Type

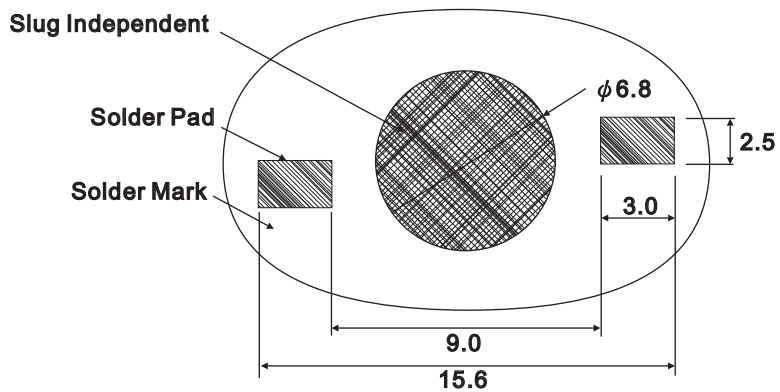

Note:

- 1.All dimensions are in millimeters.
- 2.Electrical isolation is required between Slug and Solder Pad.

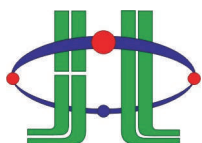

HUEY JANN ELECTRONICS INDUSTRY CO., LTD.

No.27 Line 466 Sec.2,Cannng-nan Rd. Wu-chi Town Taichung Shien, Taiwan, R.O.C.

TEL:+886-4-26393976 FAX:+886-4-26393125

Heat Plate Soldering Condition For Emitter Type

a. Soldering Process for Solder Paste

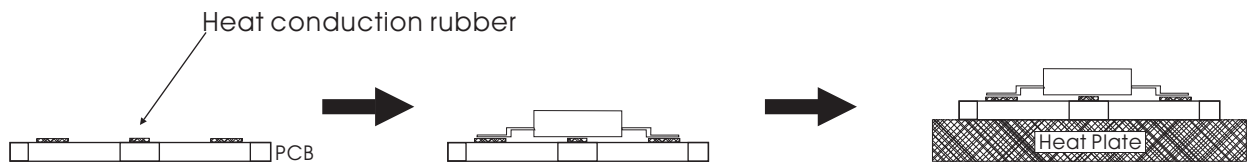

Use Solder Mask to print Solder Paste on PCB.

Place Emitter on PCB.

Put PCB on Heat Plate until Solder Paste melt.

- 1.The Solder Paste could be melted within 10 seconds.
- 2.Take out PCB out from Heat Plate within 15 seconds.

b. Soldering Process for Solder Wire

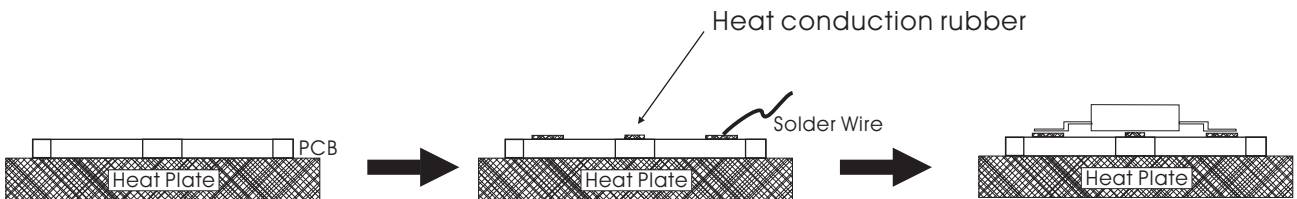

Put PCB on Heat Plate.

Place Solder Wire to the solder pad of PCB.

Put Emitter on PCB. Take the PCB out from Heat Plate within 10 seconds.

NOTE:

- 1.Heat plate temperature: 230°C max for Lead Solder and 260 °C max for Lead-Free Solder.
- 2.When soldering, do not put stress on the LEDs during heating.
- 3.After soldering, do not warp the circuit board.

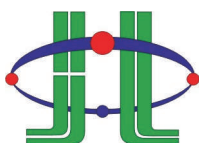

HUEY JANN ELECTRONICS INDUSTRY CO., LTD.

No.27 Line 466 Sec.2,Cannng-nan Rd. Wu-chi Town Taichung Shien, Taiwan, R.O.C.

TEL:+886-4-26393976 FAX:+886-4-26393125

Soldering Process For Hot Bar For Emitter Type

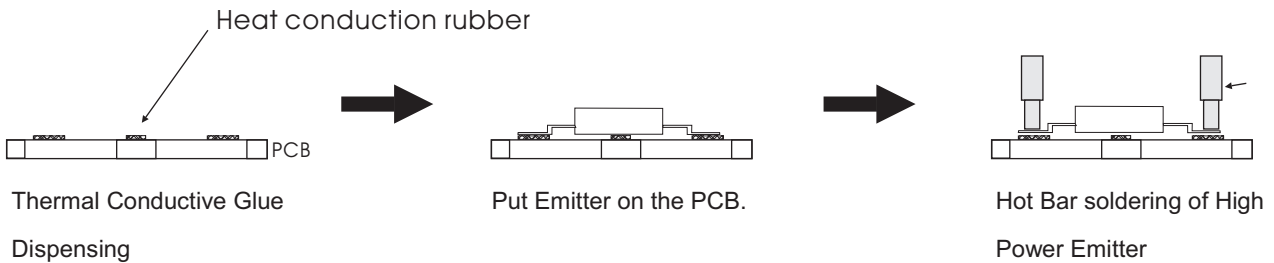

NOTE:

- 1.Hot Bar temperature: 230°C max for Lead Solder and 260°C max for Lead-Free Solder.
- 2.When soldering, do not put stress on the LEDs during heating.
- 3.After soldering, do not warp the circuit board.

Manual Hand Soldering For Emitter Type

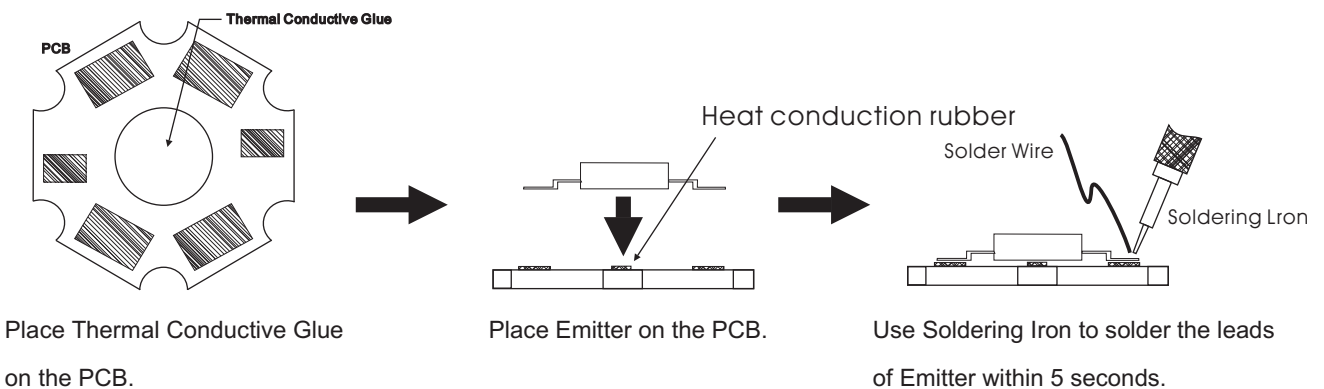

- 1.Solder tip temperature: 230°C max for Lead Solder and 260°C max for Lead-Free Solder.
- 2.Avoiding damage to the emitter or to the PCB dielectric layer. Damage to the epoxy layer can cause
- 3.Do not let the solder contact from solder pad to back-side of PCB. This one will cause a short circuit and damage emitter.

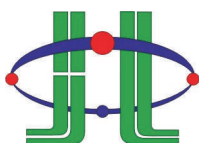

HUEY JANN ELECTRONICS INDUSTRY CO., LTD.

No.27 Line 466 Sec.2,Cannng-nan Rd. Wu-chi Town Taichung Shien, Taiwan, R.O.C.

TEL:+886-4-26393976 FAX:+886-4-26393125

Reflow Solder Condition For Emitter Type

| Profile Feature | Sn-Pb Eutectic Assembly | Lead-Free Assembly |
|--|-------------------------------|-------------------------------|
| Average Ramp-Up Rate (T_{max} To T_p) | 3 °C/sec max | 3 °C/sec max |
| Average Ramp-Down Rate | 6 °C/sec max | 6 °C/sec max |
| Preheat Temperature Min Temperature Max Time | 100 °C 150 °C 60-120sec | 150 °C 200 °C 60-180sec |
| Time Maintained Above Temperature (T_L) Time Max | 180 °C 150sec | 210 °C 150sec |
| Peak Temperature (T_p) | 240 °C | 260 °C |
| Time Within 5°C of Actual Peak Temperature (t_p) | 10 ~ 30sec | 20 ~ 40sec |

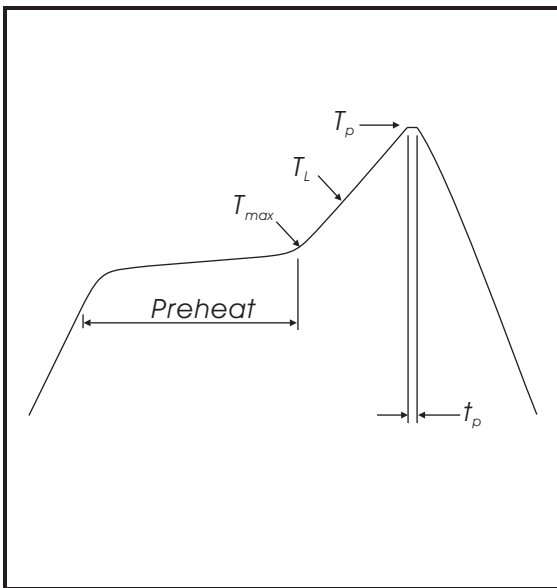

Note:

- 1.All temperature regarding topside of the package, measured on the package body surface.
- 2.After the LEDs have been soldered repairing should not be done. When repairing is unavoidable, a heat plate should be used. It should be confirmed beforehand whether the characteristics of LEDs will or will not be damaged by repairing.
- 3.Reflow soldering more than two times is not recommended.
- 4.While soldering do not put stress on the LEDs during heating.
- 5.After soldering do not warp the circuit board.

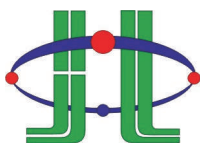



HUEY JANN ELECTRONICS INDUSTRY CO., LTD.

No.27 Line 466 Sec.2,Cann-g-nan Rd. Wu-chi Town Taichung Shien, Taiwan, R.O.C.

TEL:+886-4-26393976 FAX:+886-4-26393125

Conclusion

Huey Jann provide simple comparison table for High Power LED, you could find your request heat dissipation area from the following table.

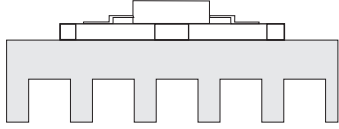
| | | | |
|----|---|---|--|
| |  <p>Free Convection Horizontal Flat Heat Dissipation-Set-up (Area Require mm²)</p> |  <p>Free Convection Vertical Flat Heat Dissipation-Set-up (Area Require mm²)</p> |  <p>Free Convection Finned Heat Dissipation-Set-up (Area Require mm²)</p> |
| 1W | 1,800 | 1,500 | 2,400 |

*TAB in this table is according to highest operating temperature 65°C.

*Different materials of second heat dissipation device, the surface area of heat sink will be different. Thus, this document is for reference only.

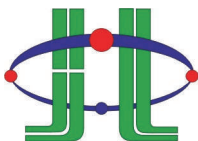

HUEY JANN ELECTRONICS INDUSTRY CO., LTD.

No.27 Line 466 Sec.2,Cannng-nan Rd. Wu-chi Town Taichung Shien, Taiwan, R.O.C.

TEL:+886-4-26393976 FAX:+886-4-26393125

TAB Temperature - Life Characteristics Curves

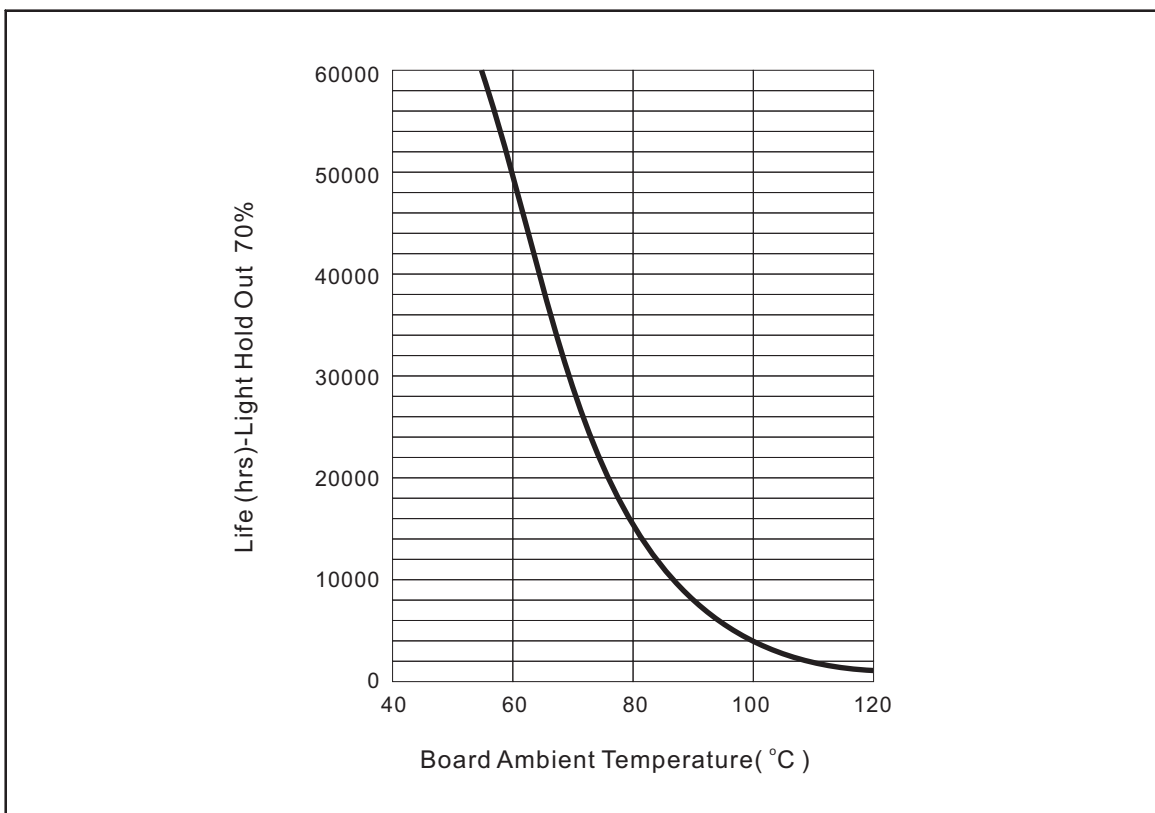
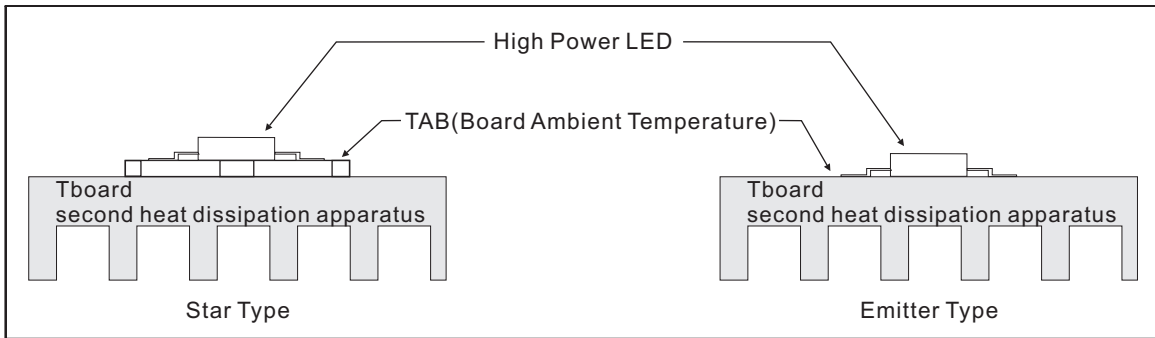

*Board Ambient Temperature Tolerance 5°C.

*TAB in this table is according to highest operating temperature 65°C.

*The TAB is the stable testing value for the product lighted 100% after one hour.

*Different materials of second heat dissipation device, the surface area of heat sink will be different. Thus, this document is for reference only.

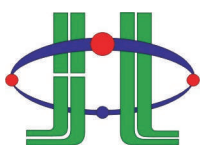

HUEY JANN ELECTRONICS INDUSTRY CO., LTD.

No.27 Line 466 Sec.2,Cannng-nan Rd. Wu-chi Town Taichung Shien, Taiwan, R.O.C.

TEL:+886-4-26393976 FAX:+886-4-26393125